

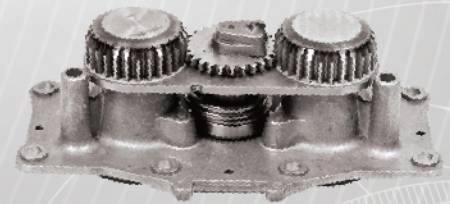

**VOTRE PARTENAIRE  
GLOBAL DANS LA  
SOLUTION DE FREINAGE**

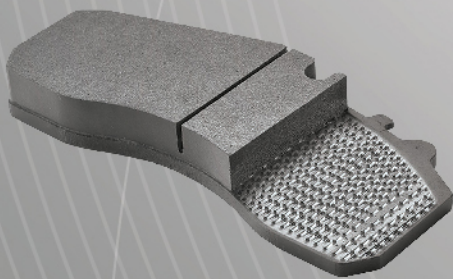
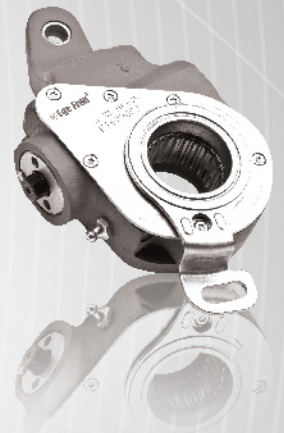
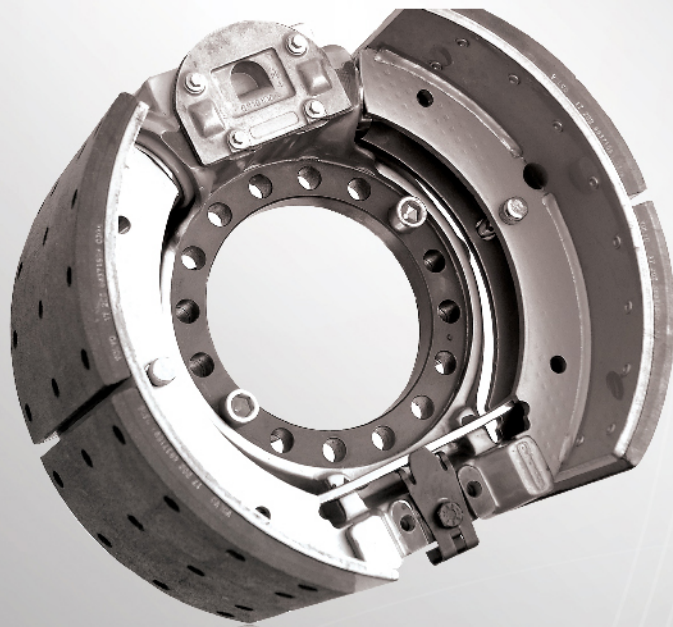
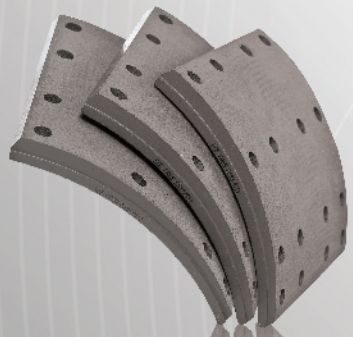

[www.egefren.com.tr](http://www.egefren.com.tr)

**LES PRODUITS APRES-VENTE**

## Clients - Services Orientés

### Haute Technologie

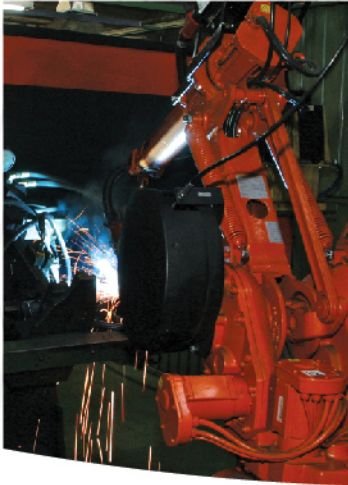

### Amélioration Continue



### Qualité En Production



### Support Logistique



**Ege Fren A.Ş.**, une entreprise commerciale du **Groupe Bayraktar** et l'un des principaux fournisseurs de système de l'automobile de **Meritor** dans le monde, a été créée en 1987 à Izmir. Nous sommes au service de nombreux constructeurs de véhicules utilitaires à la fois en Turquie et à l'étranger ainsi que la conception et la production de freins et tous leurs composants. De part la Turquie, la marque Ege Fren est acceptée comme la qualité et le symbole de service dans les différentes régions du monde comme l'Amérique, Europe, Asie, Moyen-Orient et en Afrique.



# Composants du Tambour de Frein



## VOLVO

### LES PIECES DE FREINS

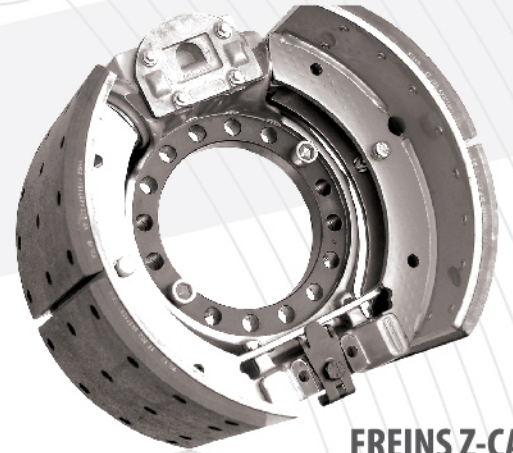

### FREINS Z-CAME

- Un ressort avec unique retour pour mâchoire, de conception optimisée de jeu hub pour faciliter l'installation.
- Les mâchoires fabriquées au poids réduite sans ressort et ayant la charge optimale plus utile que possible, tout en améliorant confort et maniabilité.

## RENAULT

### PIECES DE FREIN

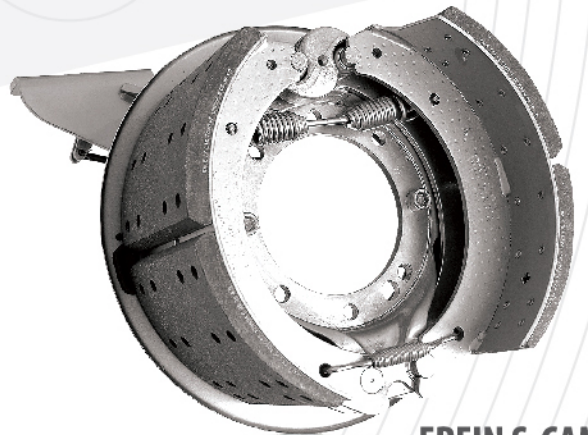
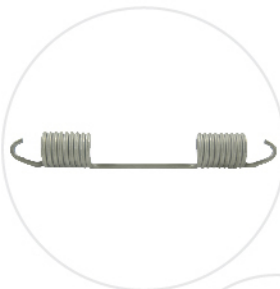

### FREIN S-CAME

- Maintenance facile.
- Le remplacement rapide de mâchoire.
- Longue vie de service.
- Ajustement automatique optionnel.

# Composants du Tambour de Frein



## IVECO PIECES DE FREIN



### PONT DE FREIN

- Ajustement Intégrante automatique.
- Les patins de frein flottants chargent aussi le tambour, améliorent la survie de la batterie et optimisent l'usure des garnitures de freins.



## REMORQUE PIECES DE FREIN

**solers**<sup>®</sup>

Solers est une marque  
d'Ege Fren A.Ş.



- Choix de livraison avec garniture et galet.
- Excellents couts/Rapport de bénéfice.

# Les Composants De Disque De Frein



## MERITOR

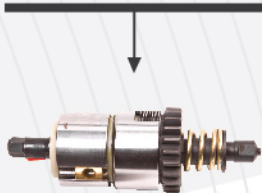

### DUCO

- B DUCO
- C DUCO
- D DUCO AXIAL
- D DUCO RADIAL
- LE DUCO



### LISA

- C LISA
- D LISA

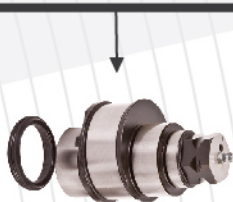

### DX195



### D3

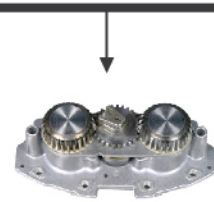

### ELSA

- ELSA 1
- ELSA 1 RADIAL
- ELSA 2
- ELSA 2 RADIAL
- ELSA 195
- ELSA 225

## KNORR

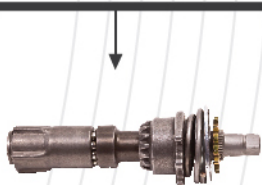

### SB5, SN5

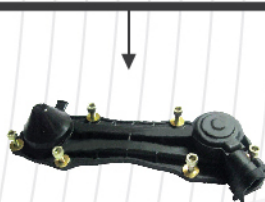

### SB6, SB7

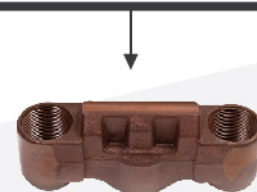

### SN6, SN7, SK7

## WABCO



### 17,5"



### 19,5"



### 22,5"

# Regleurs De Jeux

**(EF) Ege Fren**

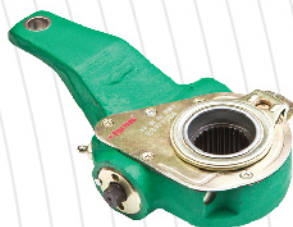
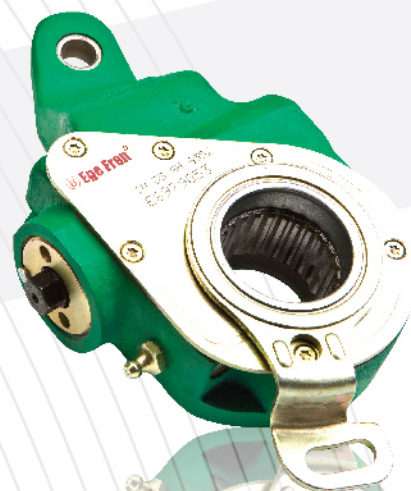

**solers®**

Solers est une marque  
d'Ege Fren A.Ş.

- Le processus de production certifiée par TUV TS16949.
- Correspondances avec les attentes du client.
- Testé par ABE - TÜV KBA.

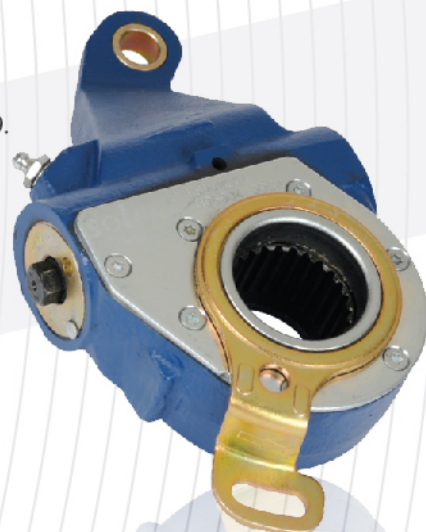

# Composants de Friction

## GARNITURES POUR TAMBOUR DE FREIN

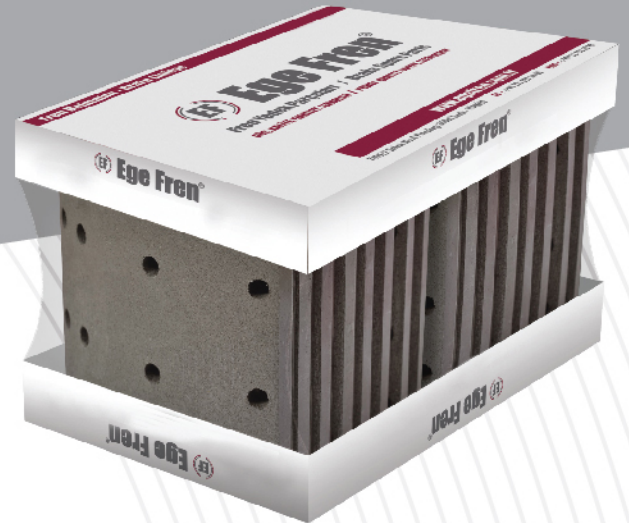
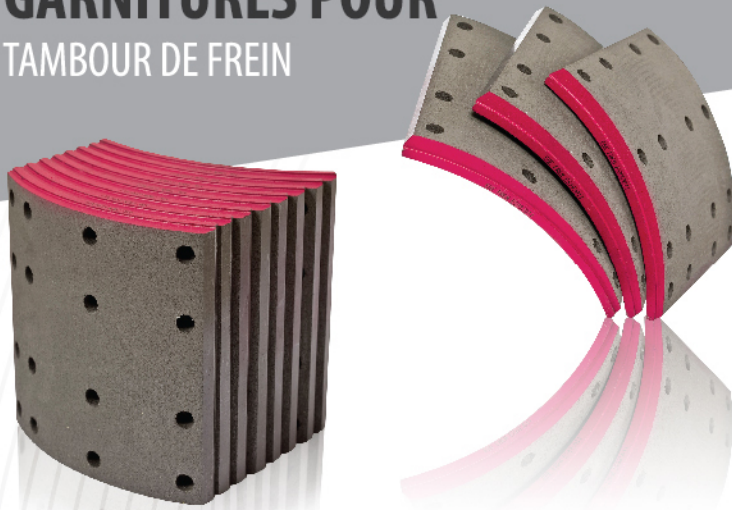

- Pour l'application des freins en pneumatiques pour autocars, camions, remorques et semi-remorques.
- Grande durabilité de conditions de travaux et de température sévères.
- Excellente compatibilité avec frein à tambour.
- Large gamme de produits pour les véhicules commerciaux.

## PATIN POUR DISQUE DE FREIN

### **Ege Fren / PREMIUM**

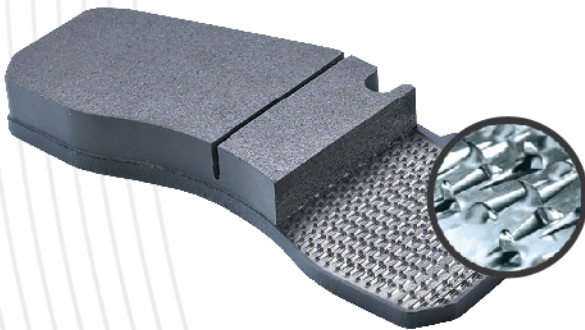

**solers**<sup>®</sup>

Solers est une marque  
d'Ege Fren A.Ş.



- Haute performance pour l'application de marche et d'arrêt.
- Haute résistance au cisaillement.
- Résistance à la chaleur pour tous les véhicules commerciaux.
- Anti-système de déviation.
- Une longue durée de patin de frein.
- Haute performance avec plaque arrière brevetée.
- Excellents couts/Rapport de bénéfice.
- Haute performance pour tout véhicules commerciaux.



# PUISSANCE, QUALITÉ, SURETÉ, TECHNOLOGIE



*Manufacture de Pınarbaşı*



*Zone Industrielle Libre*

**EGE FREN INDUSTRIE ET COMMERCE A.Ş.**

7405/2 Rue No: 4 35060 Pınarbaşı-Izmir-Turquie

Tél : +90 232 397 36 07 Fax : +90 232 478 62 98

yp@egefren.com.tr www.egefren.com.tr

